



US00D730207S

(12) **United States Design Patent**
Ben Josef et al.

(10) **Patent No.:** **US D730,207 S**

(45) **Date of Patent:** **** May 26, 2015**

(54) **SPIRIT LEVEL**

Primary Examiner — Antoine D Davis

(71) Applicant: **KAPRO INDUSTRIES LTD.**, Bikat Beit Hakerem (IL)

(74) *Attorney, Agent, or Firm* — Novick, Kim & Lee, PLLC; Harold L. Novick

(72) Inventors: **Rafi Ben Josef**, Kibbutz Kadarim (IL); **Amy Levinson**, Upper Galilee (IL); **Yossi Palatshe**, Tiberias (IL)

(57) **CLAIM**

The ornamental design for a spirit level, substantially as shown and described.

(73) Assignee: **KAPRO INDUSTRIES LTD.**, Bikat Beit Hakerem (IL)

DESCRIPTION

(**) Term: **14 Years**

(21) Appl. No.: **29/501,602**

(22) Filed: **Sep. 5, 2014**

(30) **Foreign Application Priority Data**

Mar. 5, 2014	(IL)	55326
Mar. 5, 2014	(IL)	55327
Mar. 5, 2014	(IL)	55328

(51) **LOC (10) Cl.** **10-04**

(52) **U.S. Cl.**
USPC **D10/69**

(58) **Field of Classification Search**
CPC G01C 9/00–9/36
USPC D10/69; 33/365, 366.11–366.27,
33/367–391

See application file for complete search history.

(56) **References Cited**

U.S. PATENT DOCUMENTS
212,823 A 3/1879 Stucky
(Continued)

FOREIGN PATENT DOCUMENTS

AU 111171 S 2/1939
(Continued)

OTHER PUBLICATIONS

Kapro Industries LTD Box Section Levels Products Page, Kapro Industries Ltd., available at http://www.kapro.com/SubCat.asp?parent=2&cat_id=6, on Aug. 16, 2010, 1 page.

(Continued)

FIG. 1 is a front perspective view of a spirit level according to a first embodiment of the invention, the spirit level including a main body, a central horizontal bubble vial housing, a right side handgrip, a left side vertical bubble vial housing and a right side vertical bubble vial housing, a left side end cap and a right side end cap;

FIG. 2 is a front elevation view of the spirit level of FIG. 1;

FIG. 3 is a top plan view of the spirit level of FIG. 1;

FIG. 4 is a left side elevation view of the spirit level of FIG. 1;

FIG. 5 is a right side elevation view of the spirit level of FIG. 1;

FIG. 6 is a rear elevation view of the spirit level of FIG. 1;

FIG. 7 is a bottom plan view of the spirit level of FIG. 1;

FIG. 8 is a front perspective view of a spirit level according to a second embodiment of the invention, the spirit level including a main body, a central horizontal bubble vial housing, a left side handgrip and a right side handgrip, a left side vertical bubble vial housing and a right side vertical bubble vial housing, a left side end cap and a right side end cap;

FIG. 9 is a front elevation view of the spirit level of FIG. 8;

FIG. 10 is a top plan view of the spirit level of FIG. 8;

FIG. 11 is a left side elevation view of the spirit level of FIG. 8;

FIG. 12 is a right side elevation view of the spirit level of FIG. 8;

FIG. 13 is a rear elevation view of the spirit level of FIG. 8; and, FIG. 14 is a bottom plan view of the spirit level of FIG. 8.

The broken lines along the main body of the second embodiment of the spirit level in FIGS. 8, 9, 10, 13 and 14 indicate that the lengths between the horizontal bubble vial housing and its adjacent handgrips, a vertical bubble vial housing and its adjacent handgrip, and an end cap and its adjacent vertical bubble vial housing can vary from the sizes as shown in FIG. 8. The broken lines form no part of the claimed design.

1 Claim, 8 Drawing Sheets

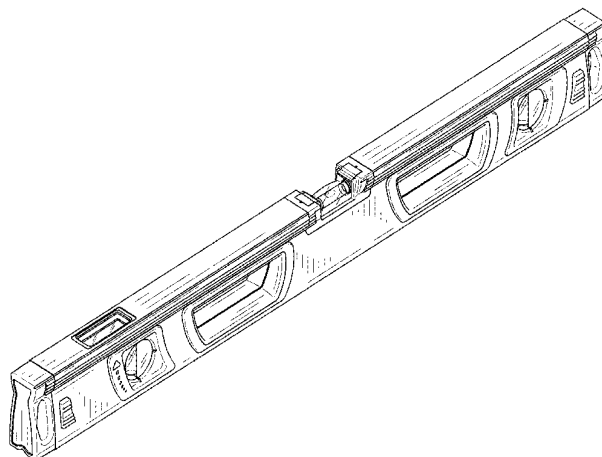

(56)

References Cited

U.S. PATENT DOCUMENTS

320,360 A 6/1885 Hutchins
 503,065 A 8/1893 Taylor
 585,653 A 7/1897 Clowe
 692,097 A 1/1902 Wood
 771,803 A 10/1904 Bishop
 999,573 A 8/1911 Lidholm
 1,034,049 A 7/1912 Wild
 1,062,964 A 5/1913 Gesbeck et al.
 1,777,429 A 10/1930 Charlton
 2,133,598 A 10/1938 Torbert, Jr.
 2,362,872 A 11/1944 Weagle
 2,373,249 A 4/1945 Lurcott, Jr.
 2,427,256 A 9/1947 Butscher
 2,453,091 A 11/1948 Holloway et al.
 2,466,829 A 4/1949 Sprinkel
 2,669,029 A 2/1954 Ries
 2,727,314 A 12/1955 Dossie et al.
 2,750,677 A 6/1956 Wirth
 2,791,036 A 5/1957 Gericke
 2,857,678 A 10/1958 Armour, Jr.
 3,064,535 A 11/1962 Anderson
 3,088,216 A 5/1963 Alexander
 3,368,287 A 2/1968 Ault
 3,603,000 A 9/1971 Ostrager
 3,694,090 A 9/1972 Ohyama
 3,738,015 A 6/1973 De Jong
 3,889,353 A 6/1975 Provi
 3,921,306 A 11/1975 Provi
 4,103,430 A 8/1978 Schrader
 4,124,940 A 11/1978 Vaida
 4,192,383 A 3/1980 Kirkland et al.
 4,332,046 A 6/1982 Foley et al.
 4,534,117 A 8/1985 Haefner et al.
 4,647,767 A 3/1987 Jubinski
 4,653,193 A 3/1987 Kennedy et al.
 4,660,292 A 4/1987 Richardson
 4,860,459 A 8/1989 Dengler
 5,020,232 A 6/1991 Whiteford
 D320,360 S 10/1991 Kennedy
 5,075,978 A 12/1991 Crowe
 5,101,570 A 4/1992 Shimura
 5,103,569 A 4/1992 Leatherwood
 5,207,004 A 5/1993 Gruetzmacher
 5,272,816 A 12/1993 Fujiwara
 D348,619 S 7/1994 Hansen
 5,361,503 A 11/1994 Anderson
 5,406,714 A 4/1995 Baker et al.
 5,414,937 A 5/1995 Denley
 D360,371 S 7/1995 O'Hare et al.
 D364,104 S 11/1995 Johnson
 5,467,532 A 11/1995 Ames
 D365,768 S 1/1996 Rodriguez
 5,588,217 A 12/1996 Lindner et al.
 5,746,004 A 5/1998 Wertheim
 5,755,037 A 5/1998 Stevens
 D459,251 S 6/2002 Scheyer
 6,418,634 B1 7/2002 Szumer
 6,449,859 B1 9/2002 Zugel et al.
 D468,221 S 1/2003 Greaves et al.
 D479,139 S 9/2003 Kallabis et al.
 6,681,494 B1 1/2004 Bowden
 D486,084 S 2/2004 Kun, Sr. et al.
 6,748,666 B2 6/2004 Zugel et al.
 D497,316 S 10/2004 Kun, Sr. et al.
 D498,152 S 11/2004 Hickey

D503,635 S 4/2005 Kallabis
 D503,636 S 4/2005 Kim
 6,957,494 B1 10/2005 Foran
 D513,391 S 1/2006 Kim
 D518,745 S 4/2006 Kim
 D518,746 S 4/2006 Kim
 D521,399 S 5/2006 Johnson et al.
 D526,224 S 8/2006 Kim
 7,228,637 B2 6/2007 Kim
 D546,214 S 7/2007 Schwartz et al.
 7,263,778 B2 9/2007 Lang et al.
 D555,523 S 11/2007 Nickel et al.
 D560,521 S 1/2008 Katz
 D563,808 S 3/2008 Schwartz et al.
 D573,908 S 7/2008 Levinson
 7,472,487 B2 1/2009 Tran et al.
 D596,056 S 7/2009 Scheyer
 D597,872 S 8/2009 Gofer
 D598,308 S 8/2009 Gofer
 D598,309 S 8/2009 Gofer
 D607,351 S 1/2010 Gofer
 7,779,545 B2 8/2010 Kallabis
 D625,631 S 10/2010 Ben-Josef et al.
 D644,944 S * 9/2011 Kallabis et al. D10/69
 8,220,171 B2 7/2012 Ben-Josef et al.
 D668,163 S 10/2012 Levinson
 2005/0039341 A1 2/2005 Hickey
 2005/0229413 A1 10/2005 Foran
 2006/0037204 A1 2/2006 Gruetzmacher
 2007/0246116 A1 10/2007 Peak et al.
 2009/0139102 A1 6/2009 Kallabis
 2011/0271537 A1 11/2011 Scheyer et al.

FOREIGN PATENT DOCUMENTS

CH 189440 A 5/1937
 CN 2938031 Y 8/2007
 DE 306455 8/1922
 DE 3125510 1/1983
 DE 8236725 5/1983
 EP 0239030 A1 9/1987
 GB 212823 A 3/1924
 GB 503065 A 3/1939
 GB 836728 6/1960
 GB 936517 9/1963
 GB 2080529 A 2/1982
 GB 2162947 A 2/1986
 GB 2222677 3/1990
 GB 2223586 A 4/1990
 JP 2-93710 7/1990
 JP 3-16018 2/1991
 JP 5-57162 7/1993
 JP 3006750 U 1/1995
 JP 8-101037 4/1996
 PL 39626 2/1957
 WO 96/03258 2/1996
 WO 2004/044524 5/2004
 WO 2006/023701 3/2006
 WO 2007/072489 6/2007
 WO 2008/107868 9/2008

OTHER PUBLICATIONS

Kapro Industries LTD I-Beam Levels Products Page, Kapro Industries Ltd., available at http://www.kapro.com/SubCat.asp?parent=2&cat_id=8, on Aug. 16, 2010, 1 page.

* cited by examiner

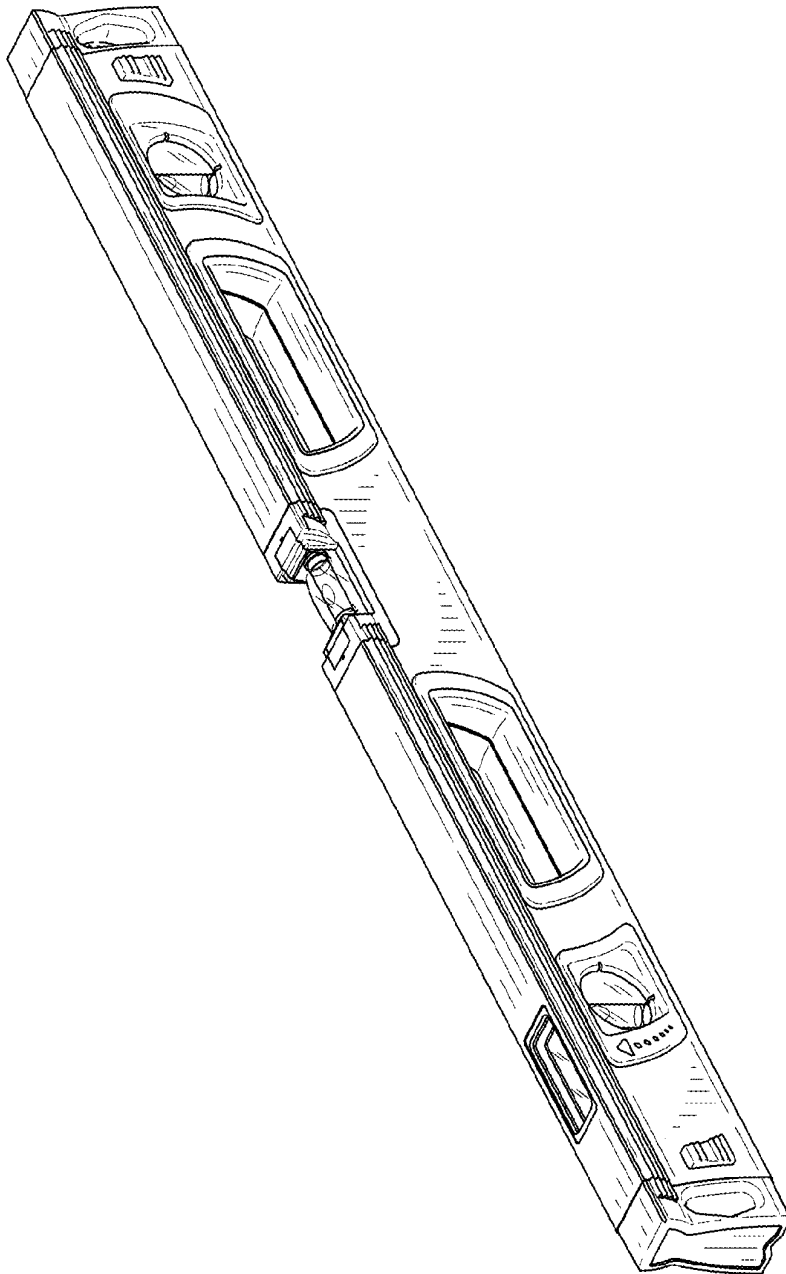

FIG.1

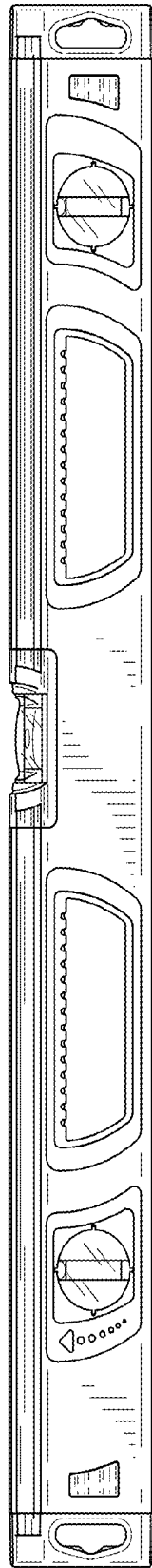

FIG. 2

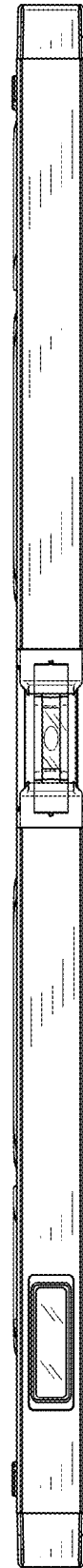

FIG. 3

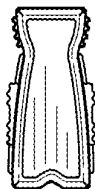

FIG. 4

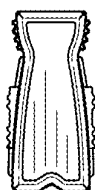

FIG. 5

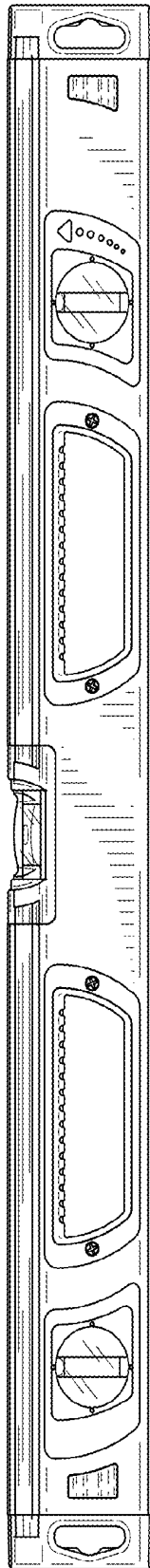

FIG. 6



FIG. 7

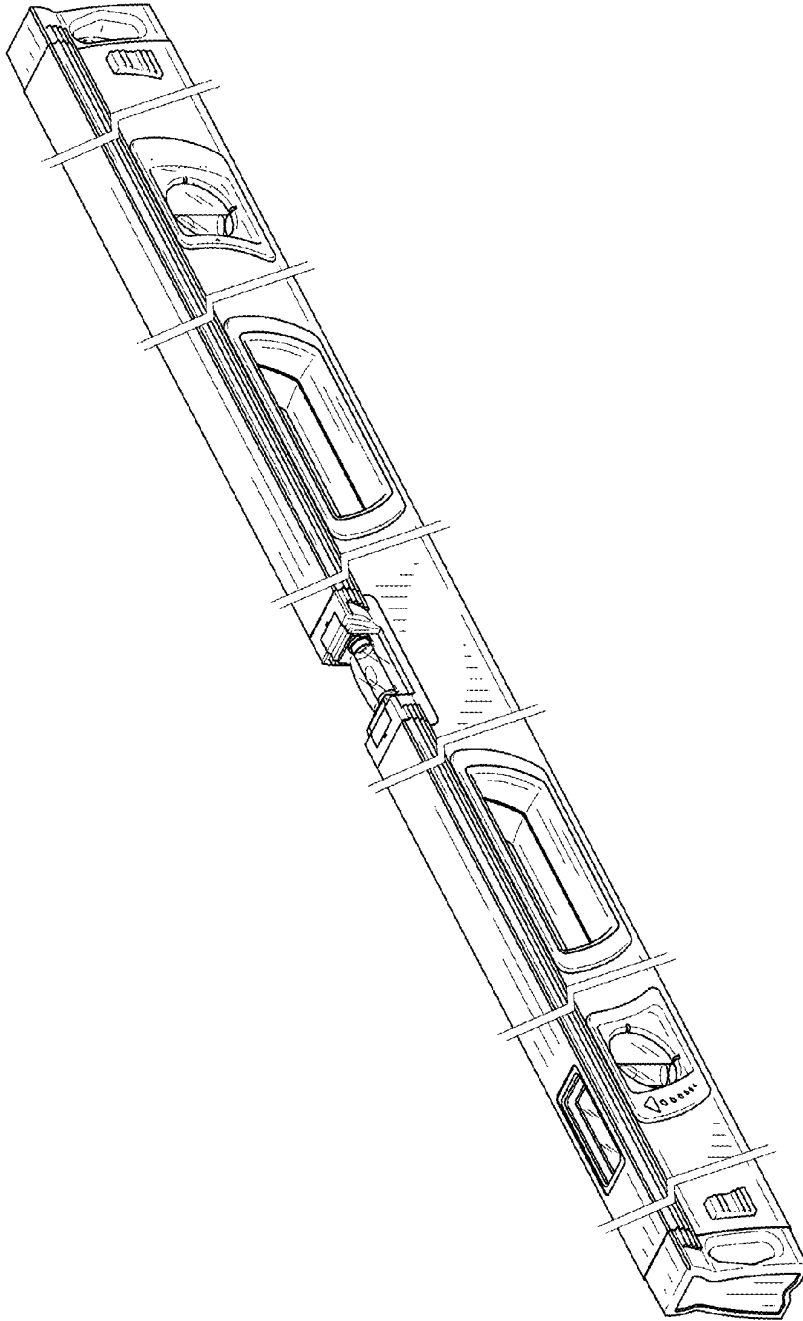

FIG. 8

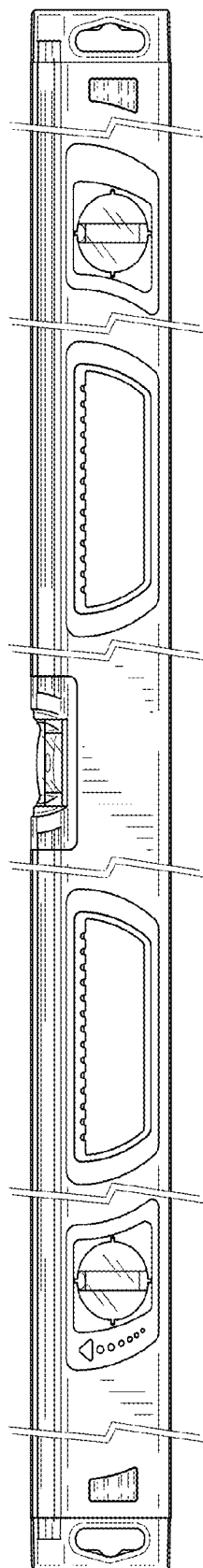

FIG. 9

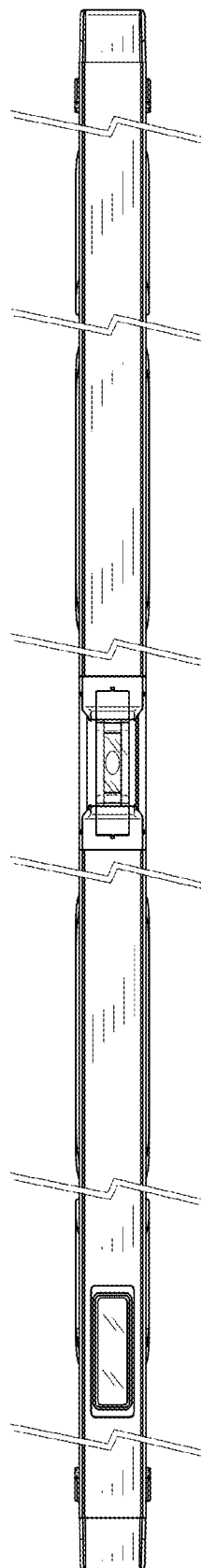

FIG. 10

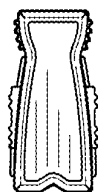

FIG.11

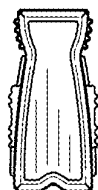

FIG.12

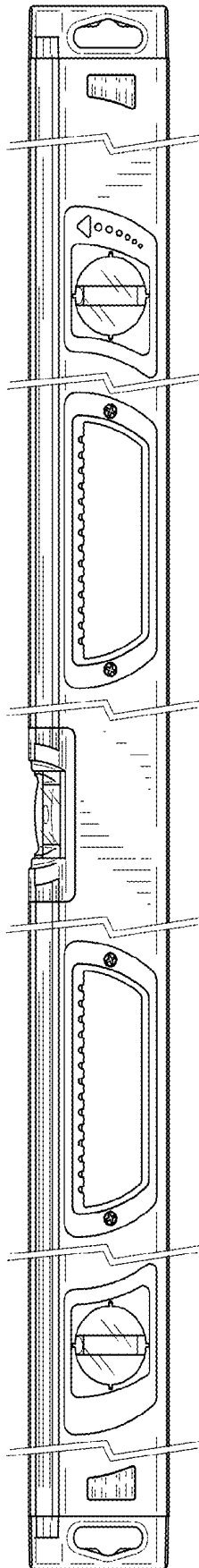

FIG. 13

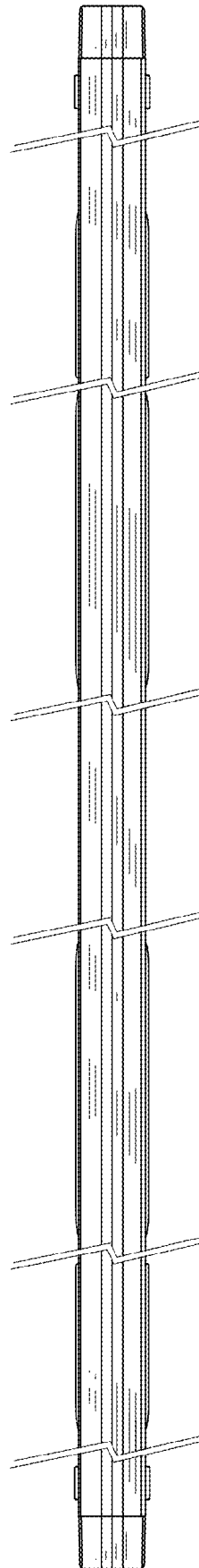

FIG. 14